

Table-Mounted Ventilation Systems

Remove Kiln & Oven Emissions at their Source!

Table-mounted ventilation systems for dental industry burnout ovens, ceramic or jewelry kilns, and any other tabletop applications to remove heat or fumes at their source.

Removing and ventilating fumes is a critical concern in today's safety-conscious work environment. A table-mounted ventilation system from Vent-A-Fume helps you provide a healthier work environment for you and your associates.

Ideal for the professional or hobbyist, table-mounted ventilation systems are easy to install and feature a close-capture design for quick and efficient removal of virtually all process emissions and an adjustable height positive-pressure system exhausts excess heat and fumes to the outside or into existing ductwork.



Vent-A-Fume's table-mounted ventilation system installed over a dental burnout oven.

Specifications & Pricing

Effective Feb. 1, 2022

Model No.	HP	RPM	CFM	Hood Size	Price
27TM265A	1/15	1550	265	27 in.	\$599.00
32TM265A	1/15	1550	265	32 in.	\$625.00
37TM265A	1/15	1550	265	37 in.	\$650.00
27TM500A	1/8	1600	500	27 in.	\$699.00
32TM500A	1/8	1600	500	32 in.	\$725.00
37TM500A	1/8	1600	500	37 in.	\$750.00

Note: All motors are 1PH/60 Hz/115V. Hood material is aluminum.

All models include:

- 1) Collection Hood
- 2) Blower
- 3) Flexible Hose & Clamps
- 4) Louver & Tailpipe
- 5) Support Stand
- 6) Support Stand Fittings

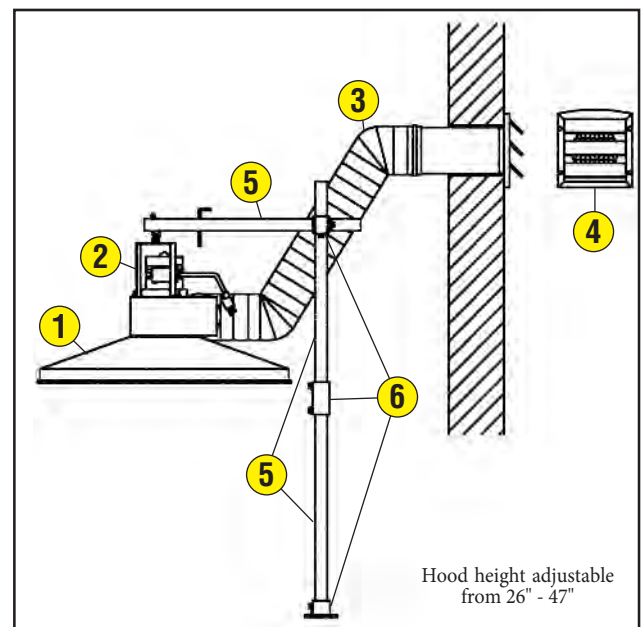

Vent-A-Fume™

Division of Vent-A-Kiln Corp.

51 Botsford Place • Buffalo, NY 14216
Phone: 716-876-2023 • Fax: 716-876-4383
Toll-Free: 877-876-8368
E-Mail: info@ventafume.com • www.VentAFume.com